

Shaft Shown in Full
C.C.W. Position

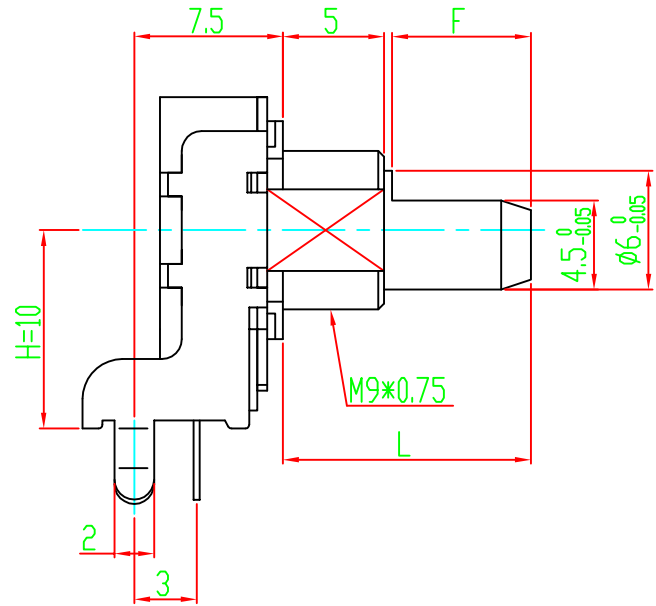

P.C.B MOUNTING DETAIL

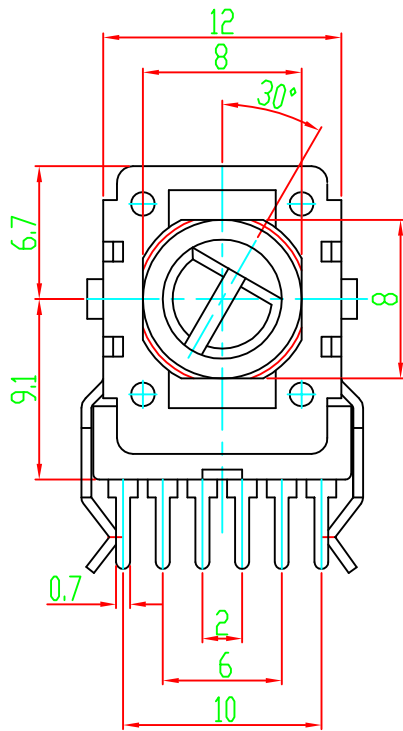
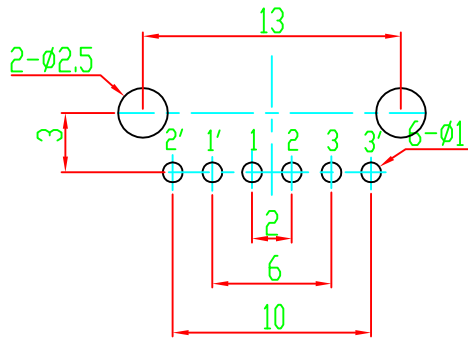

L	12.5	17.5	20	25	30
F	7	12	12	12	12

02				05		
01				04		
	DATE	REVISION	APPROVED	03		

MODEL: WH124A-2 L12.5F7 "一"字槽

DRAWING NO:



常州宇豪电子有限公司

CHANGZHOU YUHAO ELECTRONIC CO.,LTD.

DRAW	CHKD	APPD
------	------	------