

Shaft Shown in Full  
C.C.W. Position

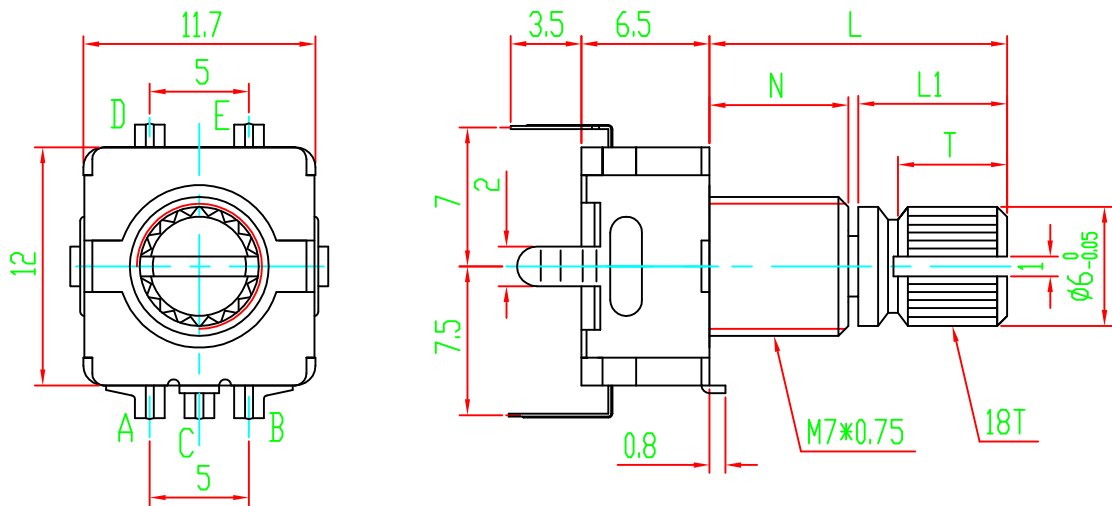

P.C.B MOUNTING DETAIL

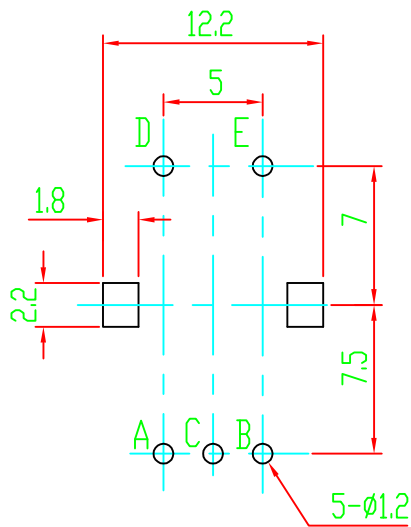

L	13	15	17	20	21.5	22	25	31.5	36	38	42
L1	5.5	7.5	9.5	12.5	14	14.5	17.5	24	28.5	30.5	34.5
T	3.5	5.5	6	9	10.5	11	11	11	11	11	11
N	7	7	7	7	7	7	7	7	7	7	7

02				05			
01				04			
	DATE	REVISION	APPROVED	03			
			MODEL: EC11-1S-D7*6.5-L20KQ 螺纹轴套				
			DRAWING NO:				
			 <b>常州宇豪电子有限公司</b> CHANGZHOU YUHAO ELECTRONIC CO.,LTD.				
DRAW	CHKD	APPD					