

Shaft Shown in Full
C.C.W. Position

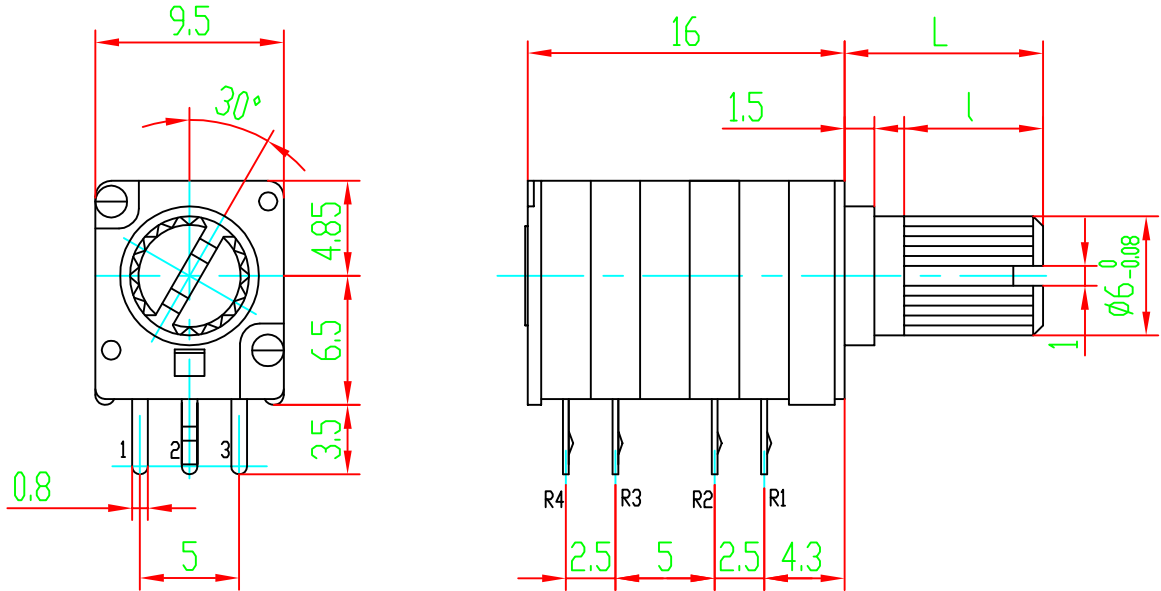

P.C.B MOUNTING DETAIL

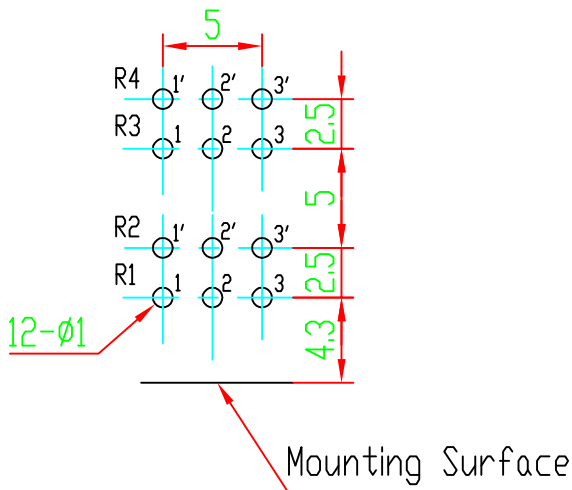

L	8	10	15	20	
l	6	7	7	12	

02				05		
01				04		
	DATE	REVISION	APPROVED	03		

MODEL: WH9011C-4 L10 18T "一"字槽

DRAWING NO:



常州宇豪电子有限公司

CHANGZHOU YUHAO ELECTRONIC CO.,LTD.

DRAW	CHKD	APPD
------	------	------